



# XE41 - R00 Series (LVHCMOS), 1.8 V

## High Reliability Hybrid Microcircuit Crystal Oscillators

( Similar to M55310/40 )

### Features

- Drop in replacement for a 5x7mm COTS Oscillator
- Ruggedized 4 Point Crystal Mount
- Tristate Output Option
- Radiation Tolerant to 10K Rads
- Low Profile Surface Mount, 0.165" Max. Height
- Low Phase Noise
- Hermetically Sealed, Ceramic Package
- ECCN: EAR99

### Applications

- High Shock & Vibration Applications
- Navigation Systems
- Aerospace Instrumentation
- Benign Space Applications
- Gun Launched Munitions

### Package Specifications & Outline:

- Package : Ceramic 90% AL<sub>2</sub>O<sub>3</sub>
- Seal: Hermetic – Resistance Welded
- Weight: 0.5 Gms typical, 0.6 Gms Max.
- Thermal Resistance, Junction to Case ( θ<sub>JC</sub> ): 30 °C / Watt
- Solder Reflow, Temp./Time: 260 °C, 10 Secs. Max.
- Lead Material & Finish: Kovar, 50 to 80 μ inches gold over 100 to 250 μ inches Nickel

Hot Solder Tinning per MIL-PRF-55310 is optional at additional cost.

Contact Xsis Electronics at [xis@xis.com](mailto:xis@xis.com) for any special requirements.

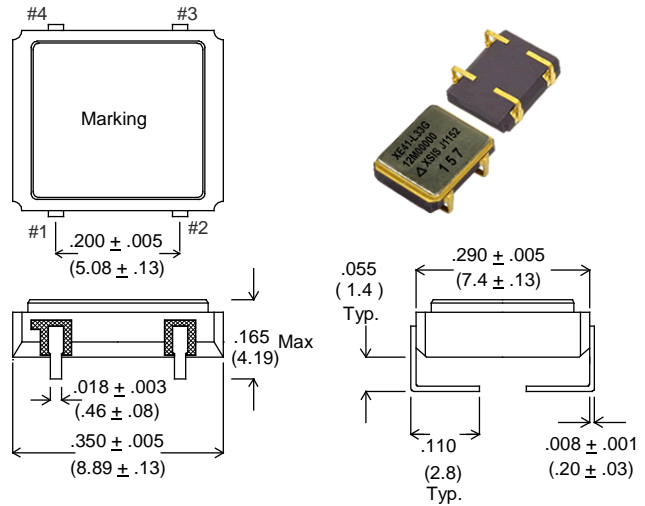

Dimensions: Inches (mm)

LEAD#	FUNCTION
1	E/D (Optional)
2	GND/CASE
3	OUTPUT
4	VDD

**E/D ( Enable/Disable ) Input:** A "Low" level at the input disables the Output into a high impedance state.

E/D Input has internal pull-up. It can be left floating or connected to Vdd.

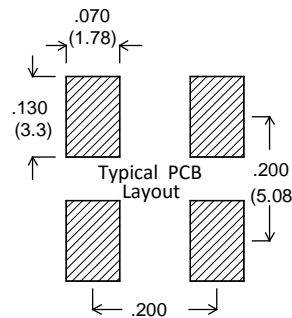

## ORDERING INFORMATION ( Please build your part number from options below ) :

P/N EXAMPLE: XE41 - R43G - M - 24.000 MHz = 1.8 V LVHCMOS, ± 50 PPM over -55 °C to +125 °C, Tristate Output, 883B Screening and 24.000 MHz

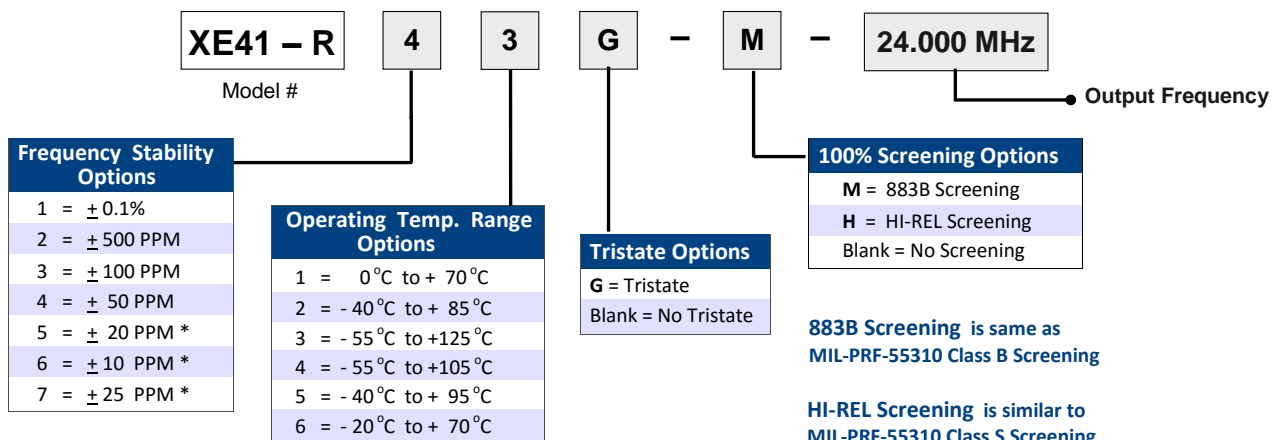

\* Frequency Stability Options 5, 6 & 7 are not available for all operating temperature ranges.



# XE41 - R00 Series (LVHCMOS), 1.8 V

High Reliability Hybrid Microcircuit Crystal Oscillators

( Similar to M55310/40 )

## Electrical Specifications:

Parameter	Specification Limits
Output Frequency Range	250 KHz to 100 MHz
Frequency Accuracy at +25 °C	± 15 PPM
Frequency Stability Vs Temperature	See Ordering Information on Page 1
Operating Temperature Range	See Ordering Information on Page 1
Supply Voltage (Vdd)	1.8 V ± 10%
Input Current (no Load )	250 KHz - 8 MHz 3 mA Max. 8.1 MHz - 16 MHz 4 mA Max. 16.1 MHz - 32 MHz 6 mA Max. 32.1 MHz - 60 MHz 10 mA Max. 60.1 MHz - 85 MHz 20 mA Max. 85.1 MHz - 100 MHz 25 mA Max.
Output Waveform	Square Wave, LVHCMOS Compatible
Output Duty Cycle ( at 50% Output Level )	< 40 MHz 55/45% Max. ≥ 40 MHz 60/40% Max.
Output High Level	0.9 Vdd Min.
Output Low Level	0.1 Vdd Max.
Output Load	10K // 15 pF
Rise & Fall Times ( Typical Load )	< 40 MHz 6 nS Max. ≥ 40 MHz 3 nS Max. ( 10% to 90% Output Levels)
Enable/Disable ( E/D)	E/D Input ≥ 0.7 Vdd or Open : Normal Output E/D Input ≤ 0.3 Vdd: High Impedance
Start-Up Time	5 mS Max.
Phase Jitter ( 10 KHz - 20 MHz Integ.)	0.35 pS rms Typical
Freq. Stability Vs Supply Voltage	± 4 PPM Max. for ± 10% change in Supply Voltage
Aging at 70 °C	± 3 PPM Max. first year, ± 2 PPM Max. per year thereafter
Absolute Maximum Applied Voltage	+ 4.5 VDC
Storage Temperature	-65 °C to +125 °C

**For special requirements, such as, tighter output symmetry, faster start-up time, PIND screening, etc., please contact Xsis Electronics at [xisis@xisis.com](mailto:xisis@xisis.com) or call us at 913-631-0448.**



***XE41 - R00 Series (LVHCMOS), 1.8 V***  
***High Reliability Hybrid Microcircuit Crystal Oscillators***  
**( Similar to M55310/40 )**

**Packaging:**

Standard packaging is in ESD protective enclosed tray. Tape & Reel packaging is available at additional cost.

**Thermal Characteristics:**

Junction to case Thermal Constant (  $\theta_{JC}$  ): 30 °C / Watt

Junction to Ambient ( Device floating in free air) Thermal Constant (  $\theta_{JA}$  ): 128 °C / Watt

**Hi-Rel Screening:**

When HI-REL option is selected, Xsis Oscillators are subjected to 100% screening similar to Class “S” screening in accordance with MIL-PRF-55310. Refer to [www.xsis.com](http://www.xsis.com) for additional details about HI-REL screening.

**Typical Phase Noise (dbc/Hz):**

Output Frequency	10 Hz	100 Hz	1 KHz	10 KHz	100 KHz	1 MHz
10 MHz	-109	-140	-157	-162	-163	-164
25 MHz	-100	-127	-151	-158	-160	-162
50 MHz	-89	-117	-148	-157	-159	-160
96 MHz	-80	-107	-139	-151	-156	-158
110 MHz	-75	-102	-130	-142	-149	-153

**Environmental Specifications:**

XE41-R00 series oscillators are designed to meet or exceed the Environmental tests specified below. Customized screening and environmental testing are also available to meet your special requirements.

Test	Test Conditions
Vibration	0.06” DA, 30 G peak, 10 - 2000 Hz, MIL-STD-202, Method 204, Cond. G
Shock	1500 G, 0.5 mS, half-Sine, MIL-STD-883, Method 2002, Cond. B
Temperature Cycling	MIL-STD-883, Method 1010, Cond. C
Thermal Shock	MIL-STD-202, Method 107, Cond. B
Seal ( Fine and Gross )	MIL-STD-883, Method 1014 Cond. A & C
Burn-in	160 Hours, 125 °C, Nominal Supply Voltage & Load
Frequency Aging	30 days at 70 °C, $\pm$ 1.5 PPM Max.
Altitude	MIL-STD-202, Method 105, Cond. C
Constant Acceleration	MIL-STD-883, Method 2001, 5000 G
Moisture Resistance	MIL-STD-202, Method 106, Vibration Sub Cycle Omitted
Solderability	MIL-STD-202, Method 208
Resistance to Soldering Heat	MIL-STD-202, Method 210, Cond B. or C as applicable
Resistance to Solvents	MIL-STD-202, Method 215
Internal Water Vapor Content	MIL-STD-883, Method 1018
ESD Classification	MIL-STD-883, Method 3015, Class 1C, HBM 1000 to 1999
Moisture Sensitivity Level	J-STD-020, MSL=1



# XE41 - R00 Series (LVHCMOS), 1.8 V

High Reliability Hybrid Microcircuit Crystal Oscillators

( Similar to M55310/40 )

## HCMOS Test Circuit

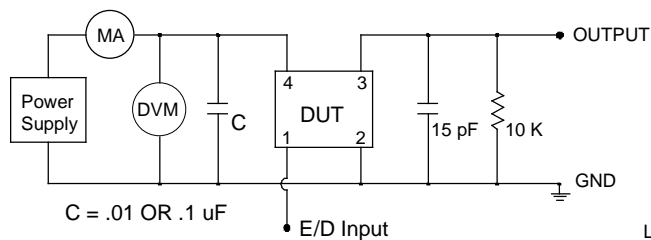

**E/D ( Enable/Disable ) Input** has an internal pull-up resistor. It can be left floating or connected to Vdd.

## HCMOS Output Waveform

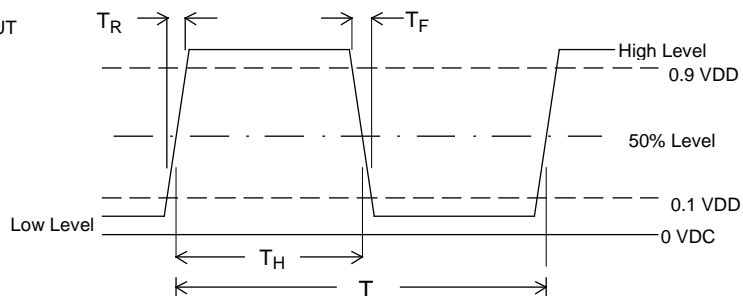

$$\text{Symmetry} = \frac{T_H}{T} \times 100 \%$$

## Typical Freq. Stability Vs. Temperature

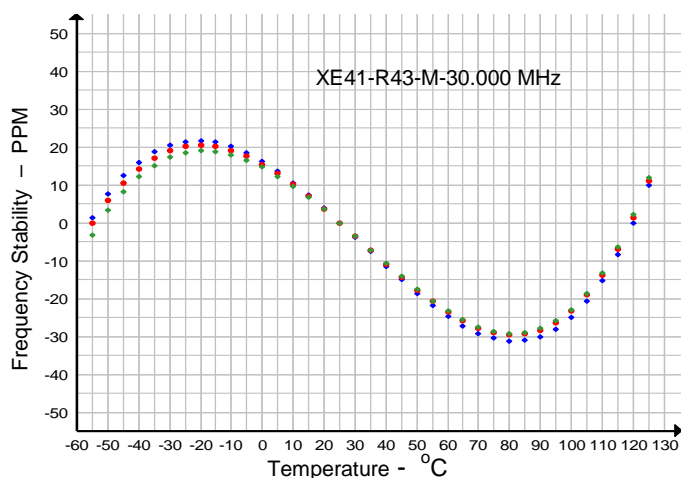

## Tape & Reel Information

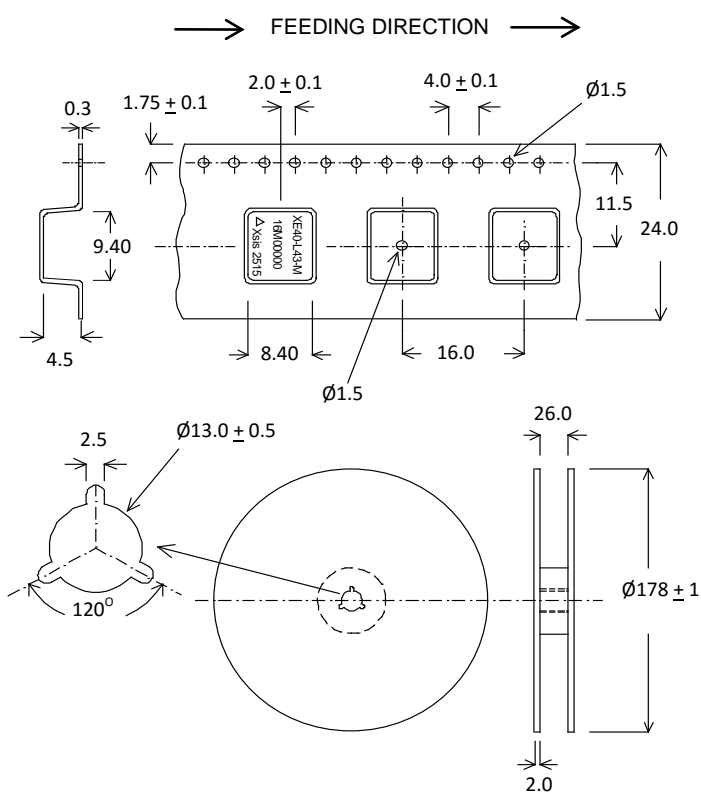

Dimensions are in mm.

## Typical Solder Reflow Profile

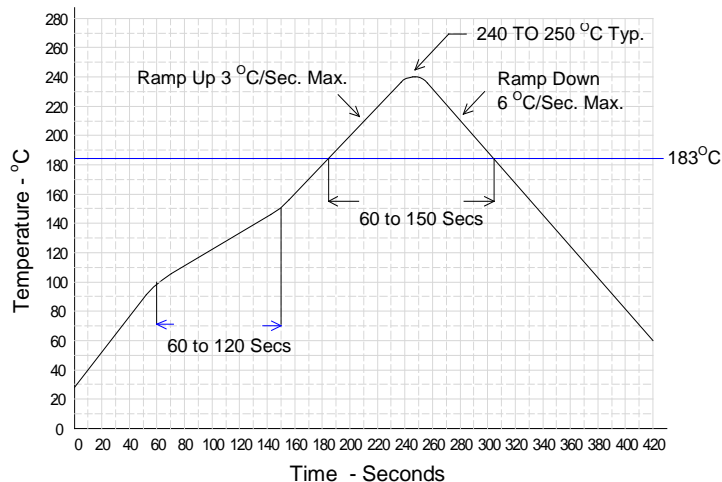

Tape is EIA-481-A Compliant.