

Description

Xsis Electronics “XH4x” Series High Temperature crystal oscillators are designed and processed to operate over an extended temperature range of -55 °C to 230 °C. These oscillators are offered in a low profile, hermetically sealed resistance welded 7x9 mm ceramic package.

High temperature materials and proven processes are utilized to provide high reliability and long life at extreme temperatures.

In addition, the quartz crystal is mounted at four points to provide excellent shock and vibration resistance.

Features

- Crystal Mounted at 4 Points
- > 10KG (0.3 mS) Shock Resistance
- 1.8V, 2.5V, 3.3V & 5.0V operation options
- 100% testing over operating temperature range
- Tristate Output Option
- Low Phase Noise
- Hermetically Sealed, Ceramic Package
- Tape & Reel packaging
- Made in USA, ECCN: EAR99

Applications

- Downhole Drilling Operations
- High Shock & Vibration
- High Temperature Avionics
- Gun Launched Munitions
- Jet Engine Sensors

Package Specifications & Outline:

- Package: Ceramic 90% AL₂ O₃
- Seal: Hermetic – Resistance Welded
- Weight: 0.5g typical, 0.8g Max.
- Thermal Resistance, Junction to Case (θ_{JC}): 38 °C / Watt
- Solder Reflow, Temp./Time: 260 °C Max for 10 Seconds Max.
- Lead Material & Finish: Kovar, 40 to 70 μ inches gold
over 100 to 250 μ inches Nickel

Contact Xsis Electronics at xisis@xisis.com for any special requirements.

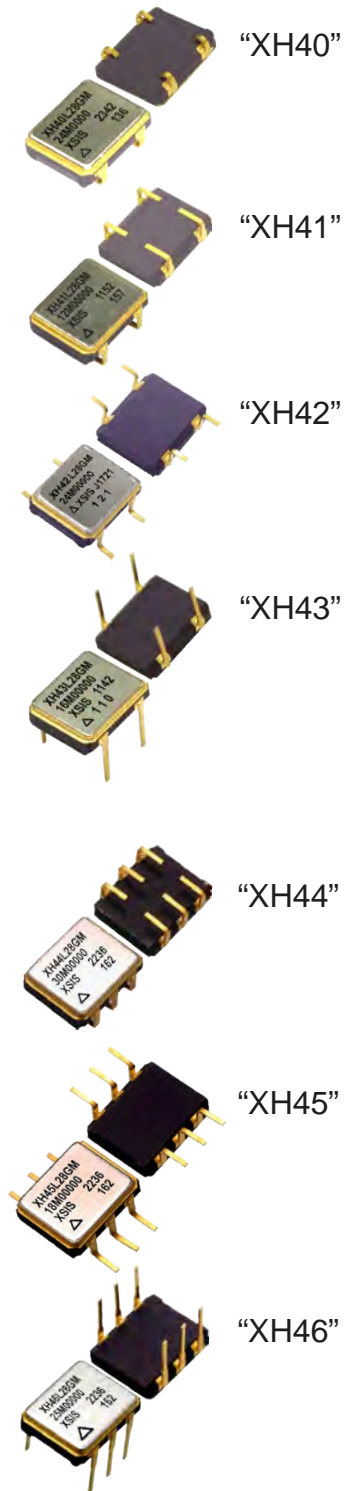

ORDERING INFORMATION (Please build your part number from options below) :

P/N EXAMPLE: XH40L - 28GM - 24.000 MHz 3.3 V LVHCMOS, ± 150 PPM Frequency Accuracy over -55 °C to +180 °C, Tristate Output, 100% Screening, 24.000 MHz

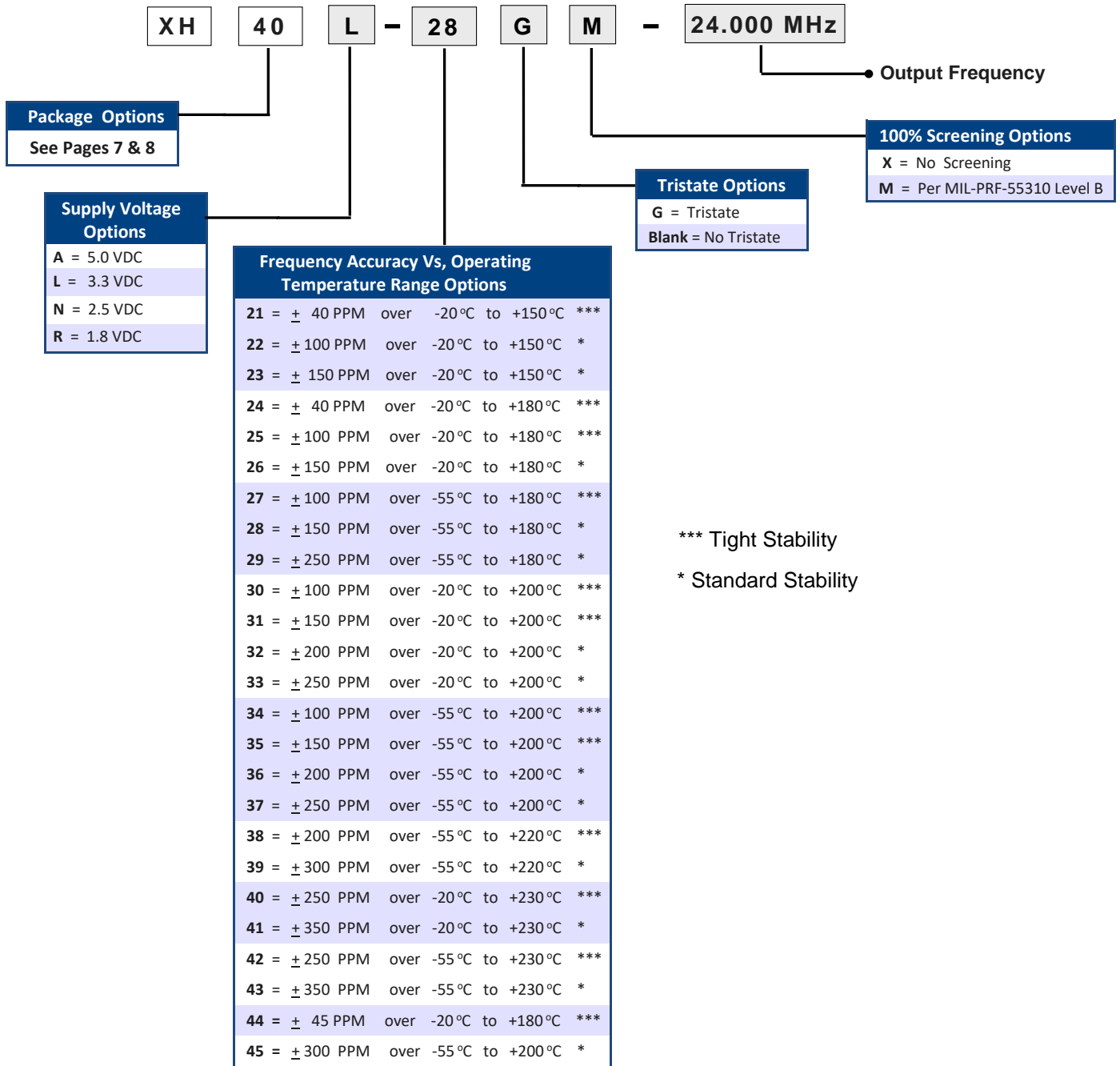

Contact Xsis Electronics at xisis@xisis.com (913-631-0448) for any special requirements.



Electrical Specifications, 5V & 3.3V HC/ACMOS Oscillators

Parameter	5 V HC/ACMOS	3.3 V HC/ACMOS
Output Frequency Range	500 KHz - 45 MHz	500 KHz - 45 MHz
Frequency Stability Vs Temperature	See Ordering Information on Page 2	
Operating Temperature Range	See Ordering Information on Page 2	
Supply Voltage (Vdd)	+ 5 VDC \pm 10%	+ 3.3 VDC \pm 10%
Input Current (No Load)	9 mA typical at 20 MHz (For Lower current option, Contact factory)	5 mA typical at 20 MHz (For Lower current option, Contact factory)
Output Waveform	Square Wave	Square Wave
Output Duty Cycle (at 50% Output Level)	40/60% Max. (For tighter symmetry, Contact factory)	40/60% Max. (For tighter symmetry, Contact factory)
Output High Level	0.9 Vdd Min.	0.9 Vdd Min.
Output Low Level	0.1 Vdd Max.	0.1 Vdd Max.
Output Load	10K // 15 pF 50 pF Max.	10K // 15 pF 50 pF Max.
Rise & Fall Times (Typical Load)	3 nS Max. (10% to 90% Output Levels)	4 nS Max. (10% to 90% Output Levels)
Enable/Disable (E/D)	E/D Input \geq 2.2V or Open : Normal Output E/D Input \leq 0.8V: High Impedance	
Start-Up Time	10 mS Max.	10 mS Max.
Phase Jitter (10 KHz - 20 MHz Integ.)	0.5 pS rms Typical	0.5 pS rms Typical
Aging at 70 °C	\pm 3 PPM Max. first year, \pm 2 PPM Max. per year thereafter	
Absolute Maximum Applied Voltage	+ 7.0 VDC	+ 4.5 VDC
Storage Temperature	-65 °C to +125 °C	-65 °C to +125 °C

NOTE: Overall Frequency Accuracy Includes, Initial Accuracy at 25 °C, Frequency changes over Operating Temperature, Aging over 5 years, Frequency changes due to Supply Voltage & Load Variations.

For special requirements, such as, tighter output symmetry, faster start-up time, PIND screening, etc., please contact Xsis Electronics at xisis@xisis.com or call us at 913-631-0448.



“XH4x” Series, 7 x 9 mm
High Temperature Hybrid Microcircuit Crystal Oscillators
(1.8 VDC, 2.5 VDC, 3.3 VDC, & 5.0 VDC 500 KHz to 45 MHz)

Electrical Specifications, 2.5V & 1.8V LVHCMOS Oscillators

Parameter	2.5 V HC/ACMOS	1.8 V HC/ACMOS
Output Frequency Range	500 KHz - 45 MHz	500 KHz - 25 MHz, Max. Temperature 230°C 25 MHz - 45 MHz, Max. Temperature 200°C
Frequency Stability Vs Temperature	See Ordering Information on Page 2	
Operating Temperature Range	See Ordering Information on Page 2	
Supply Voltage (Vdd)	+ 2.5 VDC \pm 10%	+ 1.8 VDC \pm 5%
Input Current (No Load)	3.5 mA Typ. at 20 MHz (For Lower current option, Contact factory)	3 mA Typ. at 20 MHz (For Lower current option, Contact factory)
Output Waveform	Square Wave	Square Wave
Output Duty Cycle (at 50% Output Level)	40/60% Max. (For tighter symmetry, Contact factory)	40/60% Max. (For tighter symmetry, Contact factory)
Output High Level	0.9 Vdd Min.	0.9 Vdd Min.
Output Low Level	0.1 Vdd Max.	0.1 Vdd Max.
Output Load	10K // 15 pF 30 pF Max	10K // 15 pF 30 pF Max.
Rise & Fall Times (Typical Load)	< 30 MHz 6 nS Max. \geq 30 MHz 3 nS Max. (10% to 90% Output Levels)	< 30 MHz 6 nS Max. \geq 30 MHz 3 nS Max. (10% to 90% Output Levels)
Enable/Disable (E/D)	E/D Input \geq 0.7 Vdd or Open : Normal Output E/D Input \leq 0.3Vdd: High Impedance	
Start-Up Time	10 mS Max.	10 mS Max.
Phase Jitter (10 KHz - 20 MHz Integ.)	0.5 pS rms Typical	0.5 pS rms Typical
Aging at 70 °C	\pm 3 PPM Max. first year, \pm 2 PPM Max. per year thereafter	
Absolute Maximum Applied Voltage	+ 4 VDC	+ 4 VDC
Storage Temperature	-65 °C to +125 °C	-65 °C to +125 °C

NOTE: Overall Frequency Accuracy Includes, Initial Accuracy at 25 °C, Frequency changes over Operating Temperature, Aging over 5 years, Frequency changes due to Supply Voltage & Load Variations.

For special requirements, such as, tighter output symmetry, faster start-up time, PIND screening, etc., please contact Xsis Electronics at xisis@xisis.com or call us at 913-631-0448.

Packaging Options:

Standard Packaging in ESD foam trays

Tape & Reel, EIA-481-A Compliant is available at additional cost

Thermal Characteristics:

Junction to case Thermal Constant (θ_{JC}): 38 °C / Watt

Typical Phase Noise (dbc/Hz):

Output Frequency	10 Hz	100 Hz	1 KHz	10 KHz	100 KHz	1 MHz
10 MHz	- 90	-122	-145	-158	-161	-164
25 MHz	-83	-111	-135	-143	-149	-157
40 MHz	-81	-108	-133	-142	-146	-154

Environmental Specifications:

XH4x series oscillators are designed to meet or exceed the Environmental tests specified below. Customized screening and environmental testing are also available to meet your special requirements.

Test	Test Conditions
Vibration	0.06" DA, 30 G peak, 10 - 2000 Hz, MIL-STD-202, Method 204, Cond. G
Shock	5000 G, 0.3 mS, half-Sine, MIL-STD-883, Method 2002, Cond. D
Temperature Cycling	MIL-STD-883, Method 1010, Cond. C
Thermal Shock	MIL-STD-202, Method 107, Cond. B
Seal (Fine and Gross)	MIL-STD-883, Method 1014 Cond. A & C
Burn-in	160 Hours, 125 °C, Nominal Supply Voltage & Load
Frequency Aging	30 days at 70 °C, \pm 1.5 PPM Max.
Altitude	MIL-STD-202, Method 105, Cond. C
Constant Acceleration	MIL-STD-883, Method 2001, 5000 G
Moisture Resistance	MIL-STD-202, Method 106, Vibration Sub Cycle Omitted
Solderability	MIL-STD-202, Method 208
Resistance to Soldering Heat	MIL-STD-202, Method 210, Cond B. or C as applicable
Resistance to Solvents	MIL-STD-202, Method 215
Internal Water Vapor Content	MIL-STD-883, Method 1018
ESD Classification	MIL-STD-883, Method 3015, Class 1C, HBM 1000 to 1999
Moisture Sensitivity Level	J-STD-020, MSL=1

HCMOS Test Circuit

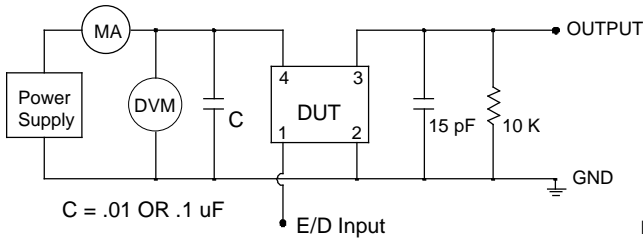

E/D (Enable/Disable) Input has an internal pull-up resistor. It can be left floating or connected to Vdd.

HCMOS Output Waveform

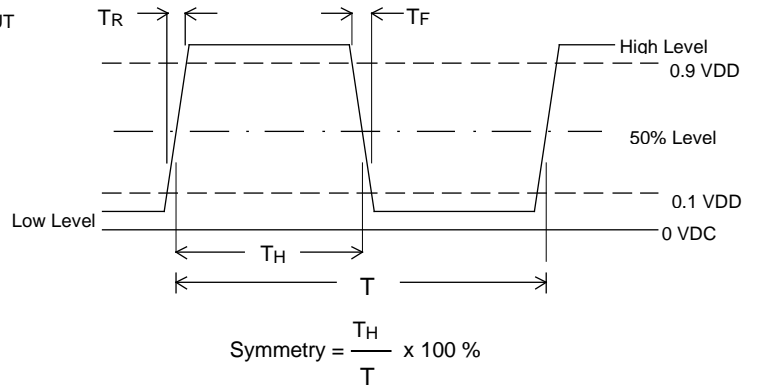

Typical Freq. Stability Vs. Temperature

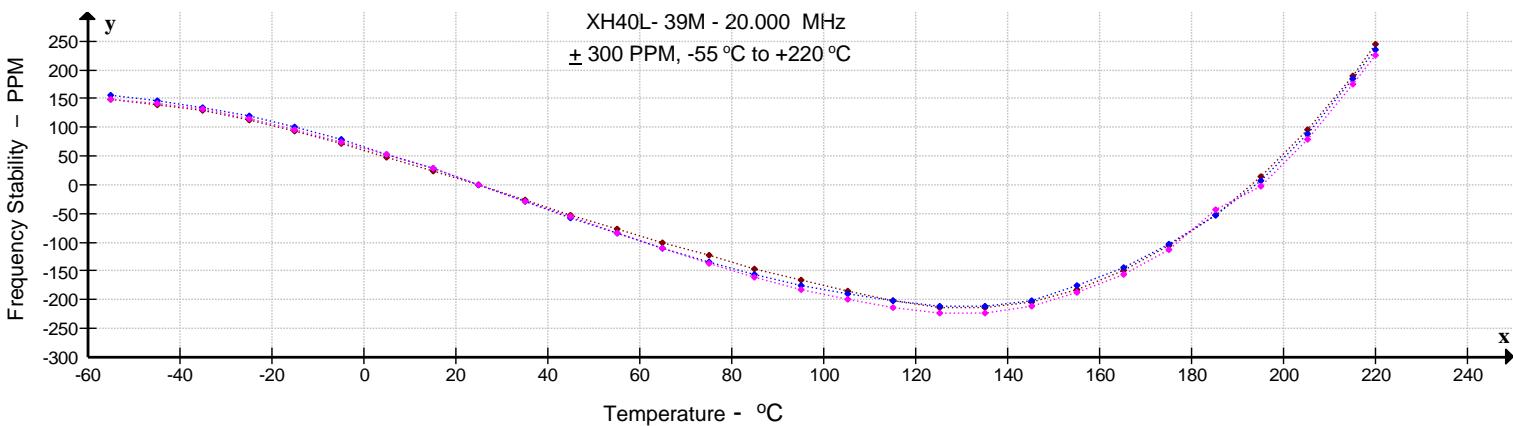
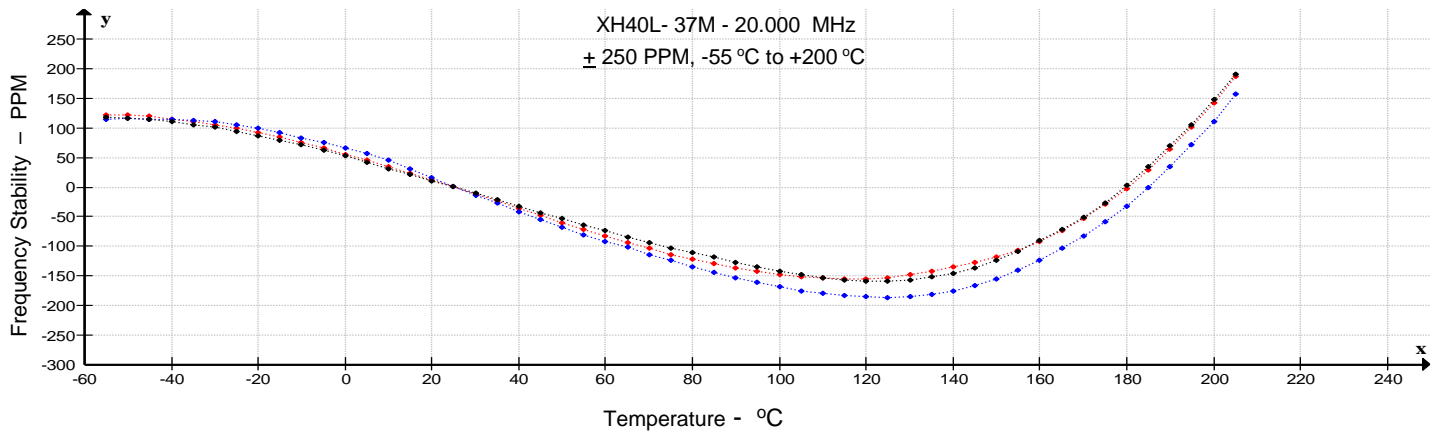

Package Outline and Pin Connections – Dimensions are in inches (mm)

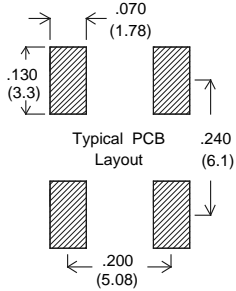
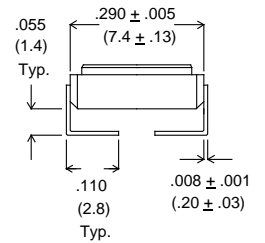
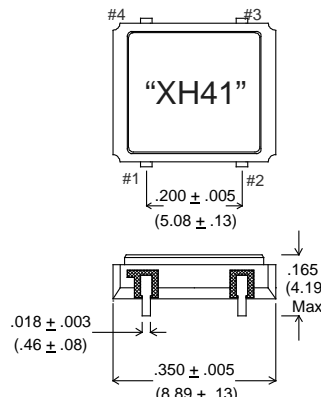
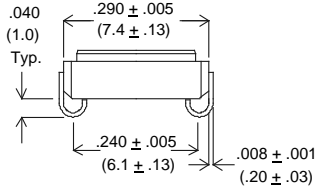
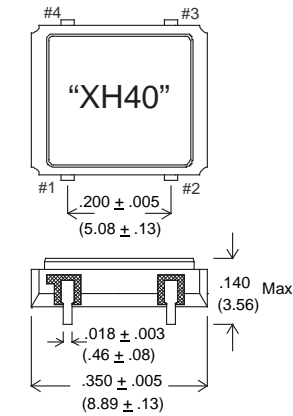

LEAD#	FUNCTION
1	E/D (Optional)
2	GND/CASE
3	OUTPUT
4	VDD

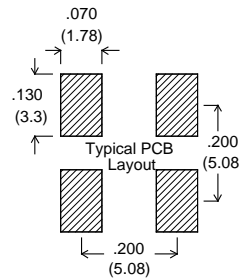

E/D (Enable/Disable) Input: A “Low” level at the input disables the Output into a high impedance state.

E/D Input has internal pull-up. It can be left floating or connected to Vdd.

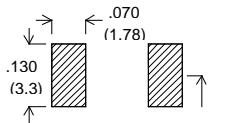
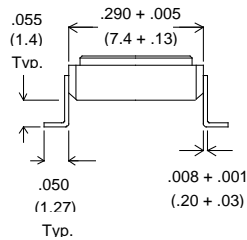
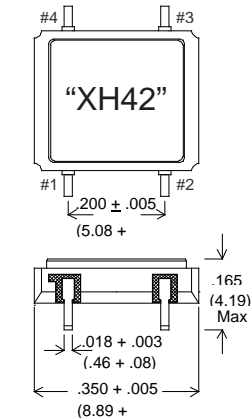

Typical PCB Layout .345 (8.76)

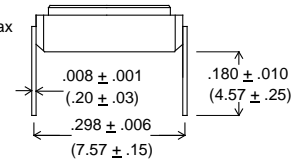
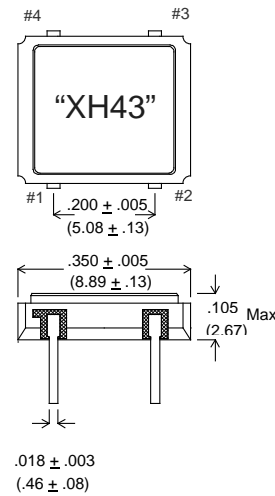
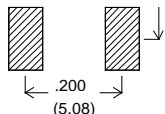

.018 ± .003 (.46 ± .08)

Package Outline and Pin Connections – Dimensions are in inches (mm)

LEAD/PAD#	FUNCTION
1	E/D (Optional)
2	N/C
3	GND/CASE
4	OUTPUT
5	N/C
6	VDD

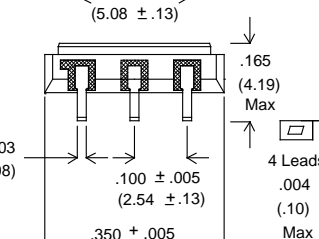
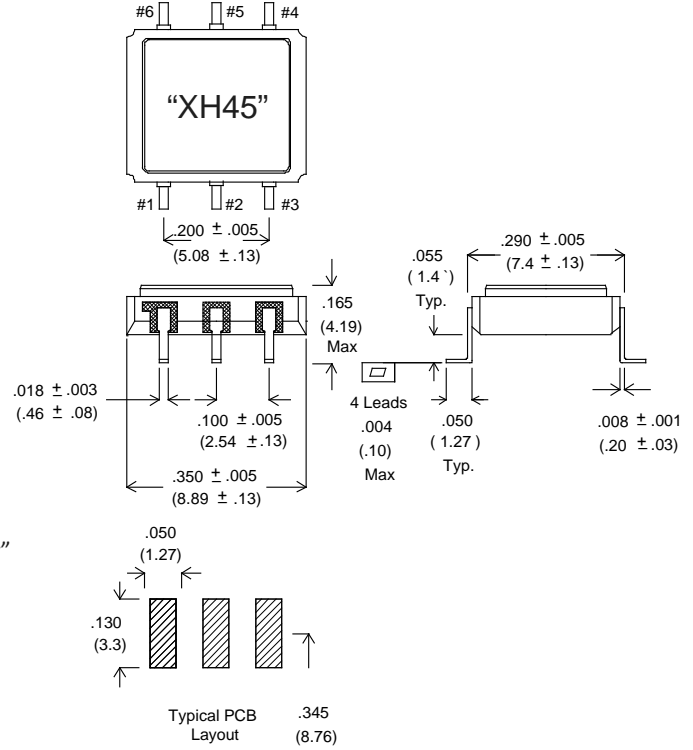
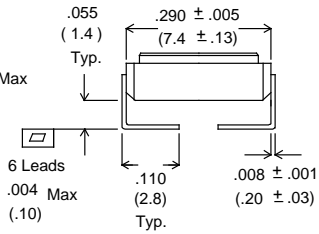
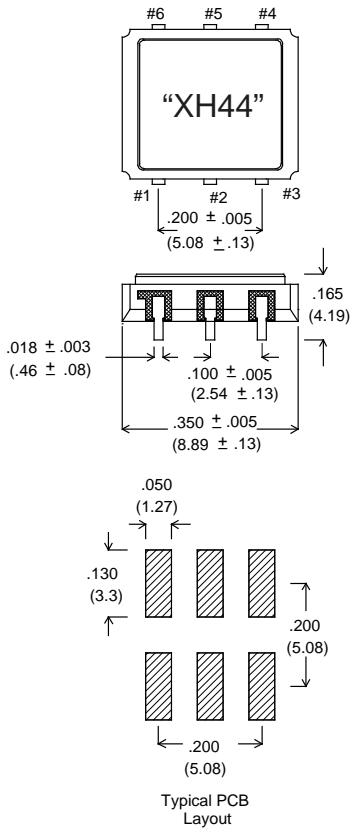

E/D (Enable/Disable) Input: A “Low” level at the input disables the Output into a high impedance state.
 E/D Input has internal pull-up. It can be left floating or connected to Vdd.

