



# “XC6L” Series, LVHCMOS, 3.3V High Reliability Hybrid Microcircuit Crystal Oscillators

( 500 KHz to 160 MHz )

## Features

- **Crystal Mounted at 4 Points**
- Ultra High Shock & Vibration Design
- Tristate Output Option
- 100% Screening Options
- Low Phase Noise
- Hermetically Sealed, Ceramic Package
- Tape & Reel packaging
- ECCN: EAR99

## Applications

- High Shock & Vibration Applications
- Navigation Systems
- Aerospace Instrumentation
- Digital Signal Processing
- Gun Launched Munitions

## Package Specifications & Outline:

- Package: Ceramic 90% AL<sub>2</sub>O<sub>3</sub>
- Seal: Hermetic – Resistance Welded
- Weight: 0.15 Gms Typical, 0.2 Gms Max.
- Thermal Resistance, Junction to Case ( θ<sub>JC</sub> ): 38 °C / Watt
- Solder Reflow, Temp./Time: 260 °C Max for 10 Seconds Max.
- Pad Finish: 0.3 to 1.0 μm gold over 1.27 to 8.9 μm nickel

Hot Solder Tinning per MIL-PRF-55310 is optional at additional cost.

Contact Xsis Electronics at [xisis@xisis.com](mailto:xisis@xisis.com) for any special requirements.

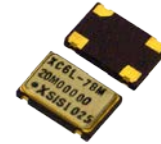
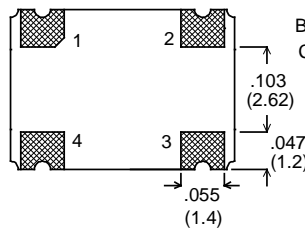
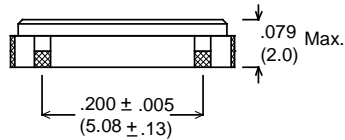
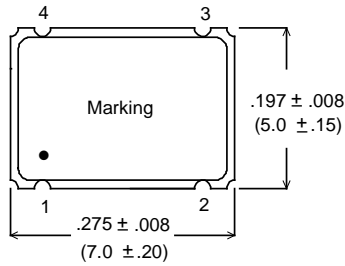

LEAD#	FUNCTION
1	E/D (Optional)
2	GND/CASE
3	OUTPUT
4	VDD

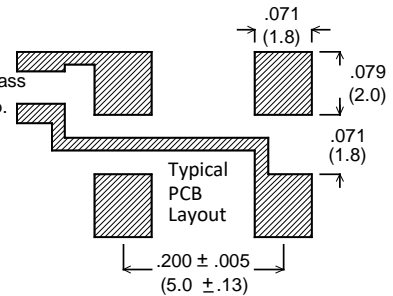

Dimensions: Inches (mm).

An External 0.01uF Bypass Capacitor is required between VDD and GND.

**E/D ( Enable/Disable ) Input:** A “Low” level at the input disables the Output into a high impedance state.

E/D Input has internal pull-up. It can be left floating or connected to Vdd.

## ORDERING INFORMATION ( Please build your part number from options below ) :

**P/N EXAMPLE: XC6L- 7BM- 24.000 MHz = 3.3 V LVHCMOS, ± 75 PPM Overall Frequency Accuracy over -55 °C to +125 °C, 55/45% Symmetry, Tristate Output , 100% Screening, 24.000 MHz**

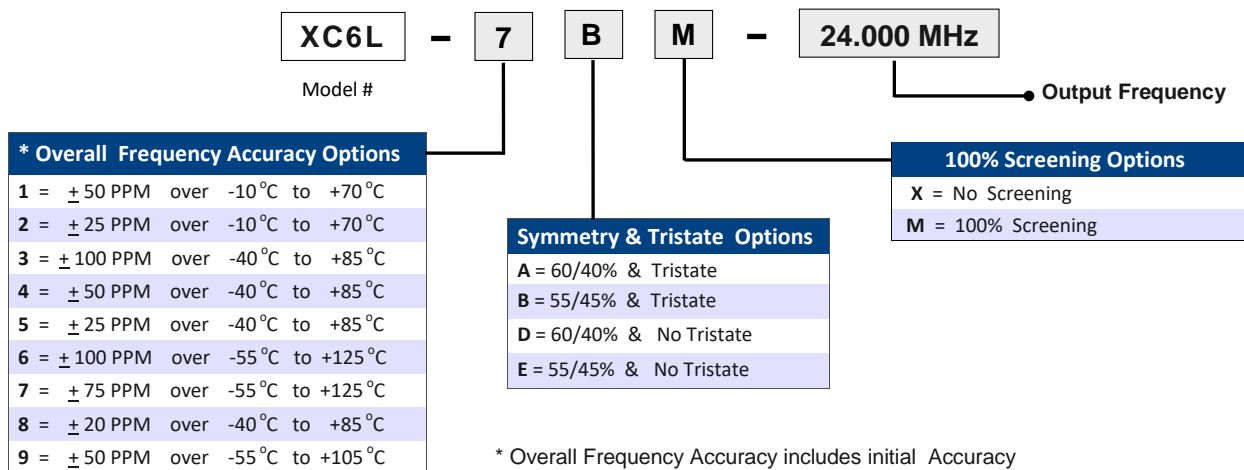

\* Overall Frequency Accuracy includes initial Accuracy & Frequency changes due to Temperature, Aging, Supply Voltage & Load variations.



**“XC6L” Series, LVHCMOS, 3.3V**  
**High Reliability Hybrid Microcircuit Crystal Oscillators**  
*( 500 KHz to 160 MHz )*

**Electrical Specifications:**

Parameter	Specification Limits
Output Frequency Range	500 KHz - 160 MHz
Overall Frequency Accuracy ( <i>See Note Below</i> )	See Options in the Ordering Information on Page 1
Operating Temperature Range	See Options in the Ordering Information on Page 1
Supply Voltage (Vdd)	+ 3.3 VDC $\pm$ 10%
Input Current (no Load)	500 KHz - 8 MHz 3 mA Max. 8.1 MHz - 32 MHz 6 mA Max. 32.1 MHz - 64 MHz 25 mA Max. 64.1 MHz - 100 MHz 40 mA Max. 100.1 MHz - 130 MHz 50 mA Max. 130.1 MHz - 160 MHz 60 mA Max
Output Waveform	Square Wave, LVHCMOS Compatible
Output Duty Cycle - HCMOS (at 50% Level)	See Options in the Ordering Information on Page 1
Output High Level	0.9 Vdd Min.
Output Low Level	0.1 Vdd Max.
Output Load	10K // 15 pF
Rise & Fall Times (Typical Load)	$\leq$ 40 MHz 6 nS Max. $>$ 40 MHz 3 nS Max. ( 10% to 90% Output Levels)
Enable/Disable ( E/D ) Input	$\geq$ 2.2V or Open : Normal Output $\leq$ 0.8V: High Impedance
Start-Up Time	10 mS Max.
Phase Jitter ( 10 KHz - 20 MHz Integrated)	0.3 pS rms Typical
Aging at 70 °C	$\pm$ 3 PPM Max. first year, $\pm$ 2 PPM Max. per year thereafter
Absolute Maximum Applied Voltage	+ 5 VDC
Storage Temperature	-65 °C to +125 °C

**NOTE: Overall Frequency Accuracy Includes, Initial Accuracy at 25 °C, Frequency changes over Operating Temperature, Aging over 5 years, Frequency changes due to Supply Voltage & Load Variations.**

**For special requirements, such as, tighter output symmetry, faster start-up time, PIND screening, etc., please contact Xsis Electronics at [xisis@xisis.com](mailto:xisis@xisis.com) or call us at 913-631-0448.**



**“XC6L” Series, LVHCMOS, 3.3V**  
**High Reliability Hybrid Microcircuit Crystal Oscillators**  
*( 500 KHz to 160 MHz )*

**Packaging:** Tape & Reel, See Page 4

**Thermal Characteristics:**

Junction to case Thermal Constant (  $\theta_{JC}$  ): 38 °C / Watt

Junction to Ambient (Device floating in free air) Thermal Constant (  $\theta_{JA}$  ): 135 °C / Watt

**Typical Phase Noise (dbc/Hz):**

Output Frequency	10 Hz	100 Hz	1 KHz	10 KHz	100 KHz	1 MHz
10 MHz	- 90	-122	-145	-158	-161	-164
25 MHz	-83	-111	-135	-143	-149	-157
50 MHz	-81	-108	-133	-142	-146	-154
96 MHz	-79	-106	-132	-141	-147	-153
110 MHz	-77	-106	-131	-140	-146	-153

**Environmental Specifications:**

XC6L series oscillators are designed to meet or exceed the Environmental tests specified below. Customized screening and environmental testing are also available to meet your special requirements.

Test	Test Conditions
Vibration	0.06" DA, 30 G peak, 10 - 2000 Hz, MIL-STD-202, Method 204, Cond. G
Random Vibration	(43.92G rms), MIL-STD-202, Method 214, Condition II-J
Shock	5000 G, 0.3 mS, half-Sine, MIL-STD-883, Method 2002, Cond. D
Temperature Cycling	MIL-STD-883, Method 1010, Cond. C
Thermal Shock	MIL-STD-202, Method 107, Cond. B
Seal ( Fine and Gross )	MIL-STD-883, Method 1014 Cond. A & C
Burn-in	160 Hours, 125 °C, Nominal Supply Voltage & Load
Frequency Aging	30 days at 70 °C, $\pm$ 1.5 PPM Max.
Altitude	MIL-STD-202, Method 105, Cond. C
Constant Acceleration	MIL-STD-883, Method 2001, 5000 G
Moisture Resistance	MIL-STD-202, Method 106, Vibration Sub Cycle Omitted
Solderability	MIL-STD-202, Method 208
Resistance to Soldering Heat	MIL-STD-202, Method 210, Cond B. or C as applicable
Resistance to Solvents	MIL-STD-202, Method 215
Internal Water Vapor Content	MIL-STD-883, Method 1018
ESD Classification	MIL-STD-883, Method 3015, Class 1C, HBM 1000 to 1999
Moisture Sensitivity Level	J-STD-020, MSL=1



# “XC6L” Series, LVHCMOS, 3.3V

## High Reliability Hybrid Microcircuit Crystal Oscillators

( 500 KHz to 160 MHz )

### HCMOS Test Circuit

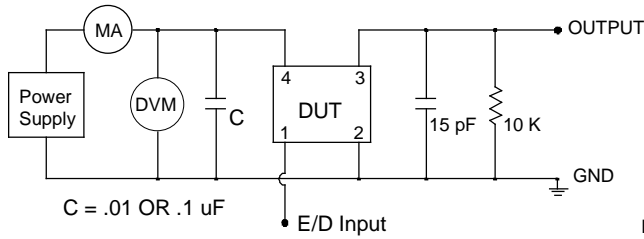

**E/D ( Enable/Disable ) Input** has an internal pull-up resistor. It can be left floating or connected to Vdd.

### HCMOS Output Waveform

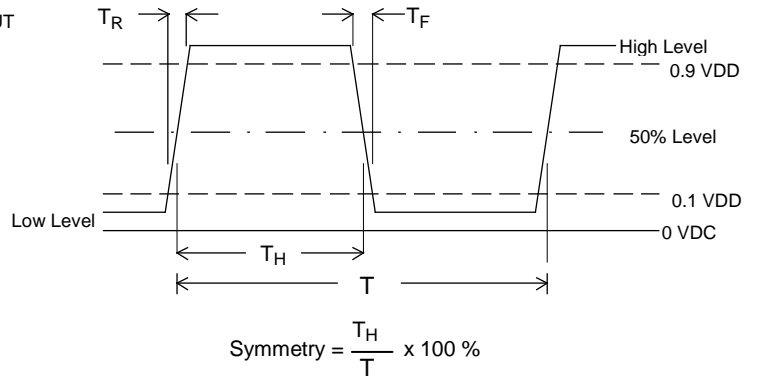

### Typical Freq. Stability Vs. Temperature

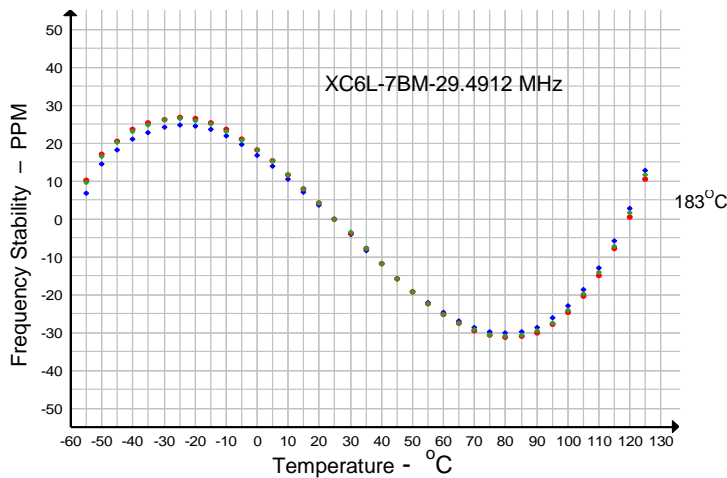

### Tape & Reel Information

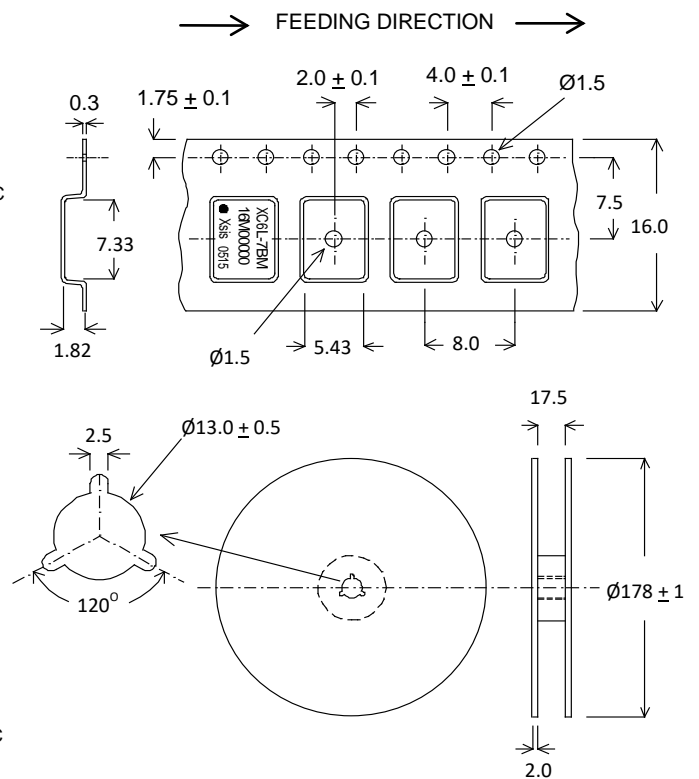

### Typical Solder Reflow Profile

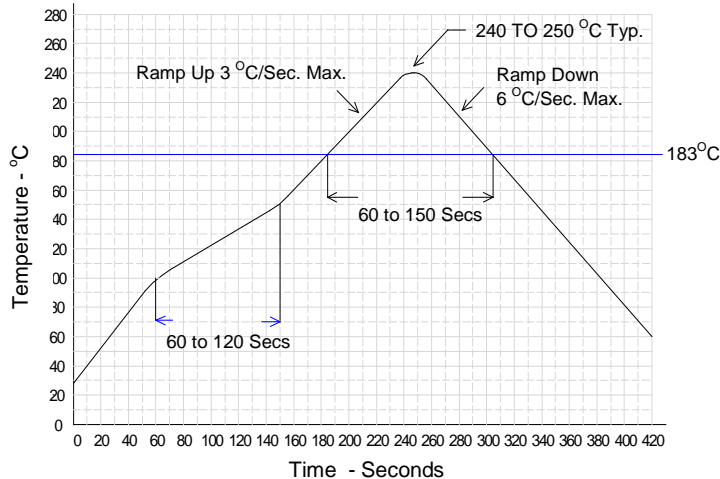

**Tape is EIA-481-A Compliant.**